

Inside IP20

Moon 14,2W/m

MO14,2

Tira de LED flexible de excelente calidad lumínica.
Ideal para instalaciones de señalización o decorativas.
Para uso interior.

Flexible LED strip with excellent light quality.
Ideal for small or decorative installations.
For indoor use.

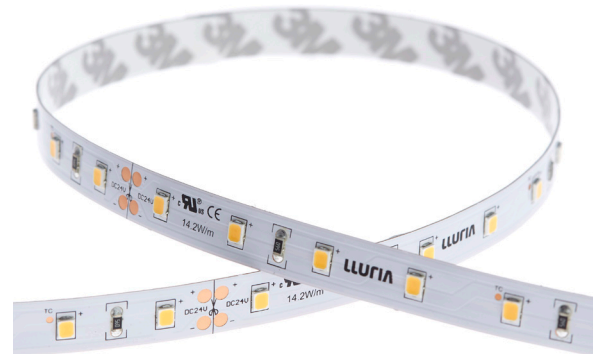
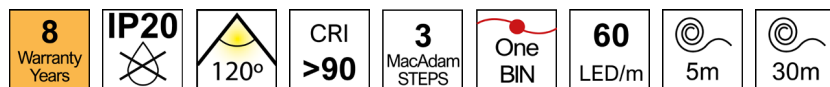

Referencia Reference	CCT	Lumens /m	Lumens /W
MO14,2-23	● 2300K	1500	106
MO14,2-27	● 2700K	1585	112
MO14,2-30	○ 3000K	1595	113
MO14,2-40	○ 4000K	1730	122
MO14,2-60	○ 6000K	1800	127
MO14,2-AB	● Ambar Amber	280	
MO14,2-AZ	● Azul Blue	252	
MO14,2-RJ	● Rojo Red	436	
MO14,2-UV	● Ultravioleta Ultraviolet	11	
MO14,2-VD	● Verde Green	730	

Características técnicas Technical data

Potencia Power	14,2W/m
Potencia rollo 5m Roll power 5m	71W
IP	20
CRI	>90
R9	>10
Voltaje Voltage	24V
Tipo de LED LED type	2835
LEDs/m	60
Pitch	16,7mm
Ángulo Beam angle	120°
Longitud mín. corte Min. cutting length	100mm
Longitud rollo Roll length	5/30m
Vida útil Life time	50.000h
Temperatura ambiente Ambient temperature	-20~50°C
Temperatura almacenamiento Storage temperature	-40~80°C
Años de garantía Warranty years	8
Regulable Dimmable	Sí Yes
Necesita disipador Needs heatsink	Sí Yes
Longitud máx. Max. length	10m ⁽¹⁾

⁽¹⁾ Conectadas en serie Connected in series



3 Pasos MacAdam 3 MacAdam steps

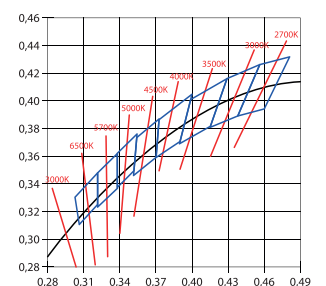

CDL

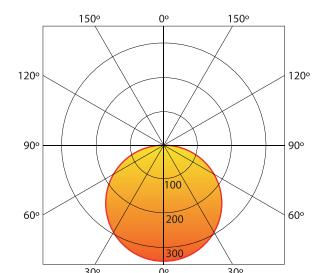

Inside IP20

Moon 14,2W/m

Medidas LED

LED dimensions



Esquema de conexión

Circuit diagram

Respete las longitudes máximas para evitar caídas de tensión y variaciones en la intensidad lumínica.
Respect the maximum lengths to avoid drops voltage and variations in light intensity.

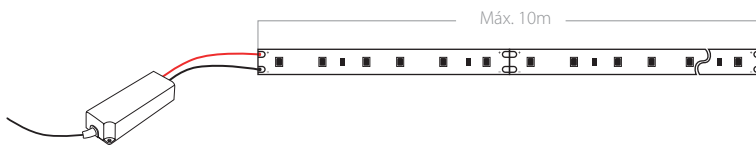

Fuente de alimentación
Power supply

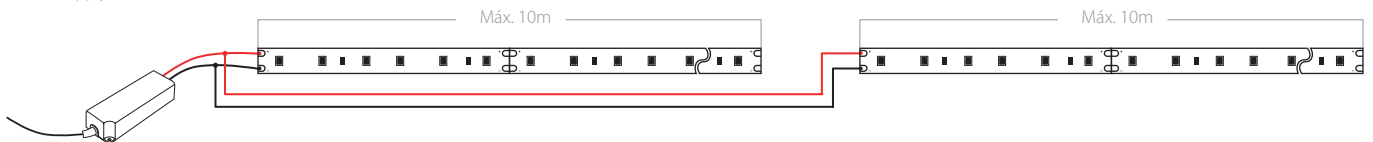

Fuente de alimentación
Power supply

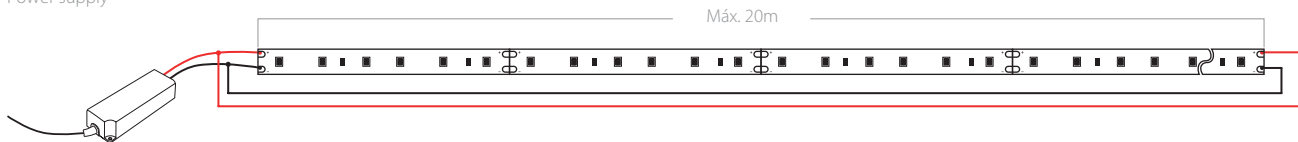

Fuente de alimentación
Power supply

Sección cable

Cable section

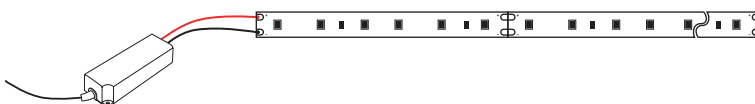

Fuente de alimentación
Power supply

	Cable		
Distancia Distance	≤ 5m	< 15m	< 25m
Sección Section	0,5mm ²	1,5mm ²	2,5mm ²



Inside IP20

Moon 14,2W/m

Distancia LED- Perfil

Distance LED- Profile

Distancia mínima que se debe dejar en los extremos, ambos lados, entre tira de LED y perfil.

Minimum distance that should be left at the ends, both sides, between LED strip and profile.

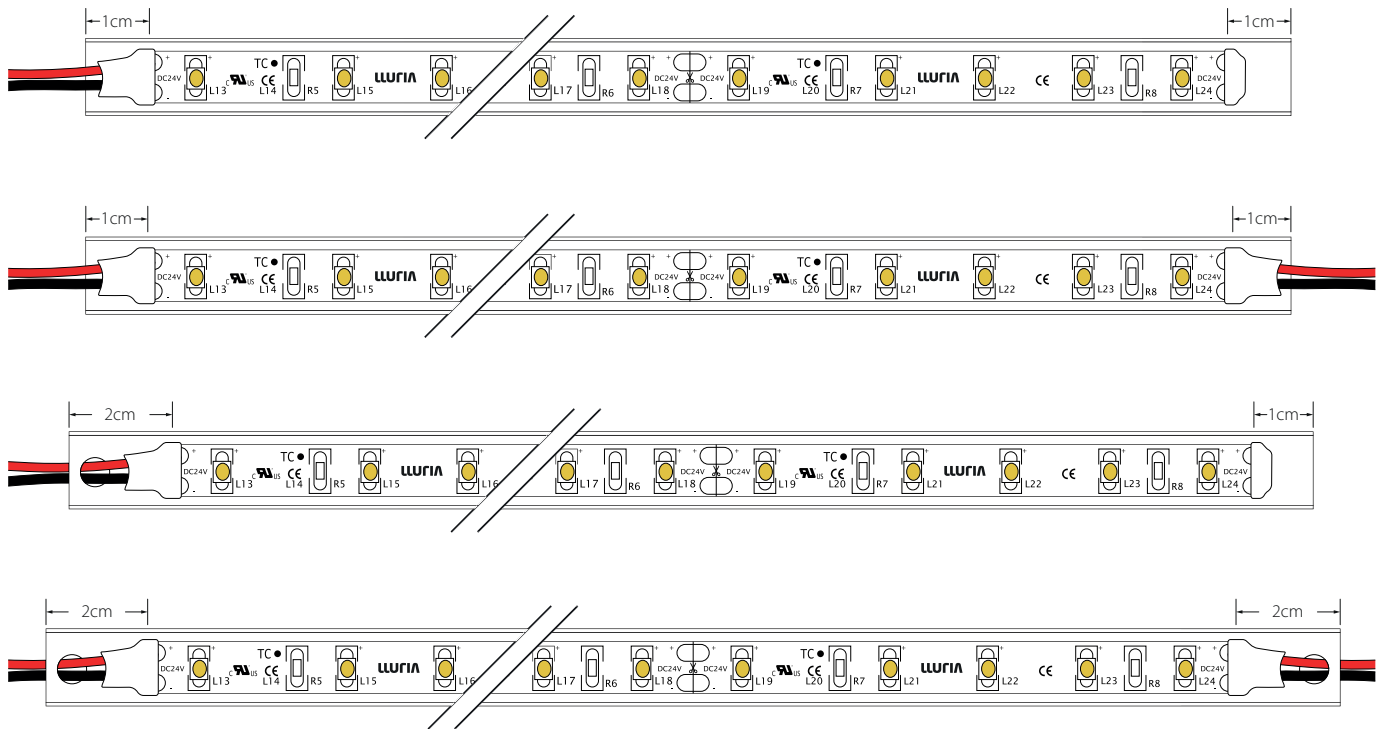

Detalle de montaje

Assembly detail

No doble la tira de LED para adaptarla a radios o ángulos pronunciados, corte por la marca y suelde un tramo de cable para poder realizar el giro.

Do not bend the LED strip to adapt them to sharp radius or angle, cut for the cut mark and weld a section of cable to make the turn.

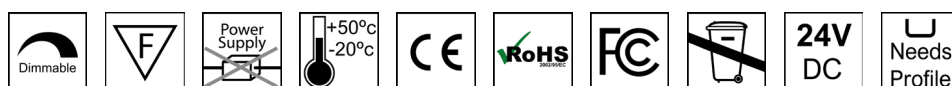
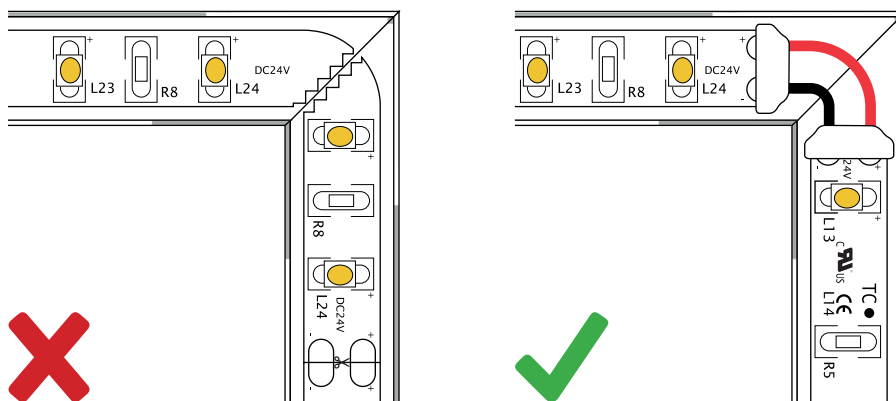

Inside IP20

Moon 14,2W/m

- **Vida útil**
Life time

La vida útil de nuestros LEDs es de 50.000h a una temperatura ambiente de 23°C y provistos de un sistema de disipación de calor. Se recomiendan ciclos de apagado para alargar la vida de los LEDs.
The life time of our LEDs is 50.000h at an ambient temperature of 23°C and provided with a heat dissipation system. Off cycles are recommended to extend the life of the LEDs.



Advertencias Warnings

- Con el fin de garantizar la vida del LED, es obligatorio colocarlo sobre una superficie que disipe el calor que generan.
- Vigile al manipular los cables para evitar daños en las soldaduras.
- Los picos de tensión pueden causar daños.
- Si se utiliza difusor con el perfil disipador, puede haber variaciones en la temperatura de color.
- To ensure the life of the LED, it is request to place on a surface that dissipates the heat they generate.
- Caution when handling cables to avoid damage to the welds.
- The voltage surges can cause damage.
- If diffuser is used with the dissipating profile, there may be variations in the color temperature.

